

CRITICAL CONTAMINATION CONTROL **COMPARISON**

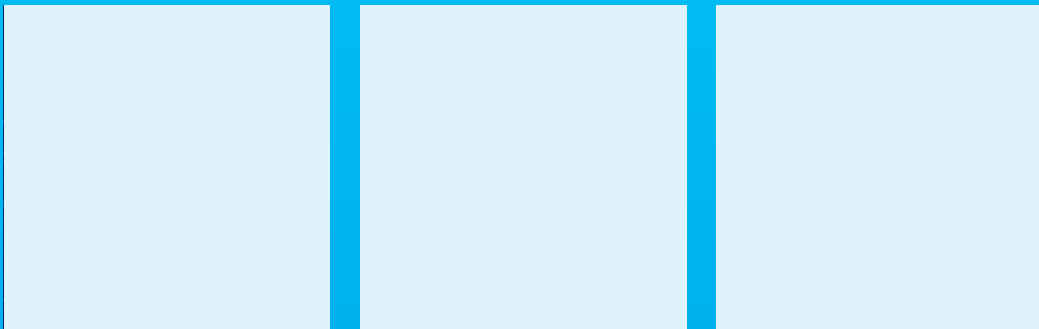

STOP CONTAMINATION IN ITS TRACKS

THE INVISIBLE ENEMY

REDUCE THE **RISK**

It's not what we can see, it's what we can't see... the small light particles (<5um) normally invisible to the naked eye are commonly called Airborne Molecular Contaminants (AMCs). They can become suspended for hours in the surrounding environment where they are quickly spread, polluting the atmosphere.

Dycem Clean Zones dramatically reduce the risk of airborne contaminants by up to 75%.



**USING NOTHING ON NORMAL FLOORING
ALLOWS PARTICLES TO SETTLE, LEADING THEM
TO BEING CRUSHED AND REDISTRIBUTED BACK
INTO THE ENVIRONMENT, CAUSING RISK TO
YOUR CRITICAL ENVIRONMENTS!**

CONTAMINATION & CROSS CONTAMINATION... A **COSTLY PROBLEM** IN MORE WAYS THAN ONE

Air, foot and wheel contamination in manufacturing, processing and storage areas can have an impact on many aspects of business, interrupting production, reducing product yields and in serious cases, ruining reputations.

The focus for conventional contamination control is airborne and personnel movement – the real problem lies at floor level so the need to control contamination is vital.

THE **RISK** TO YOUR **BRAND**

Your company's reputation will be tarnished, perhaps irreparably, if you have to recall a contaminated product.

THE **RISK** TO YOUR **PROFITS**

Your bottom line – your company's ultimate financial well-being – will suffer every time you have to recall a product.

THE **RISK** TO **HEALTH & SAFETY**

The health and safety of your employees and customers will be endangered by a contaminated environment and contaminated products.

THE VISIBLE AND INVISIBLE RISK

Contamination control is a major and growing concern in cleanrooms, critical areas and controlled environments.

Cleanrooms are markedly cleaner than a hospital operating room and require an extremely stringent approach to controlling possible contamination and ensuring an environment is free of bacteria, viruses or other pathogens.

Particulate contaminants are known to adversely affect quality, product yield, operational effectiveness and profitability, therefore protecting these areas is vital.

Whether the environment you operate in is industrial, controlled, critical or sterile, Dycem enables all organisations to reduce particle counts by up to 99.9%.

The illustration below identifies the types of particulates present in these environments and how Dycem uses these groups to assess and address your facility's decontamination needs.

VISIBLE RISK

**SAND, SALT GRAIN,
SMALL DEBRIS**



**FIBRES, ALLERGENS,
POLLENS**



INDUSTRIAL
(SUPERCOARSE)
100 micron +

Environments include heavy wheeled pallet trucks, trolleys and forklifts.

Typical locations include:
Warehouses, Factories, Goods in/out

CONTROLLED
(COARSE)
10 - 100 micron

Environments include heavy wheeled forklifts, medium to light wheeled pallet trucks, trolleys and pedestrian traffic.

Typical locations include:
Transfers Areas, Loading Bays, Granulation Bays





© Mark Herboth Photography
Clean Room Design by Mark Paskanik, AIA; Perkins+Will

INVISIBLE RISK

A major misconception is believing a regularly cleaned floor harbours no particles or contaminants.

Particles below a size of 30 microns are not visible so no matter how clean the floor may look, viable and non viable particles will be present.

Dycem's contamination control specialists offer an on-site survey and demonstration to assess the cleanliness of your facilities.

INVISIBLE RISK

PATHOGENS, BACTERIA, SPORES



NANOPARTICLES, MICROBES

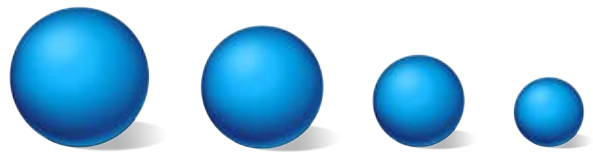

CRITICAL

(FINE)

0.5 - 10 micron

Environments include light weight trolleys and pedestrian traffic.

Typical locations include:

Changing Rooms, Air Showers, Gowning Areas

STERILE

(ULTRAFINE)

0.5 micron <

Environments include pedestrian traffic.

Typical locations include:

Pedestrian Airlocks, Isolation Chambers, Aseptic Processing

HIGH PERFORMANCE CONTAMINATION CONTROL ZONES

Contamination from foot, wheel and airborne microbial particles is something we often dismiss as “dust”. Yet, the dangers it poses can be devastating. A single microbe in a batch of aseptic drugs could cause the entire batch to be quarantined or scrapped, leading to supply shortages, financial consequences, product recalls, FDA warning letters or even company shutdown.

80% of contamination entering your critical environment does so on feet or wheels. Therefore, controlling contamination and cross contamination at or near floor level is a fundamental part of any integrated risk management policy.

There are different types of products on the market that claim to inhibit contamination.

This brochure has been created to evaluate **the many options of Contamination Control**, including the following:

- Nothing** 6
- Peel-off mats** 7 - 11
- Foot baths** 12
- Shoe covers** 14
- Performance Comparisons** 15 - 16
- Dust or Dirt mats** 17 - 18
- Dycem** 19 - 26

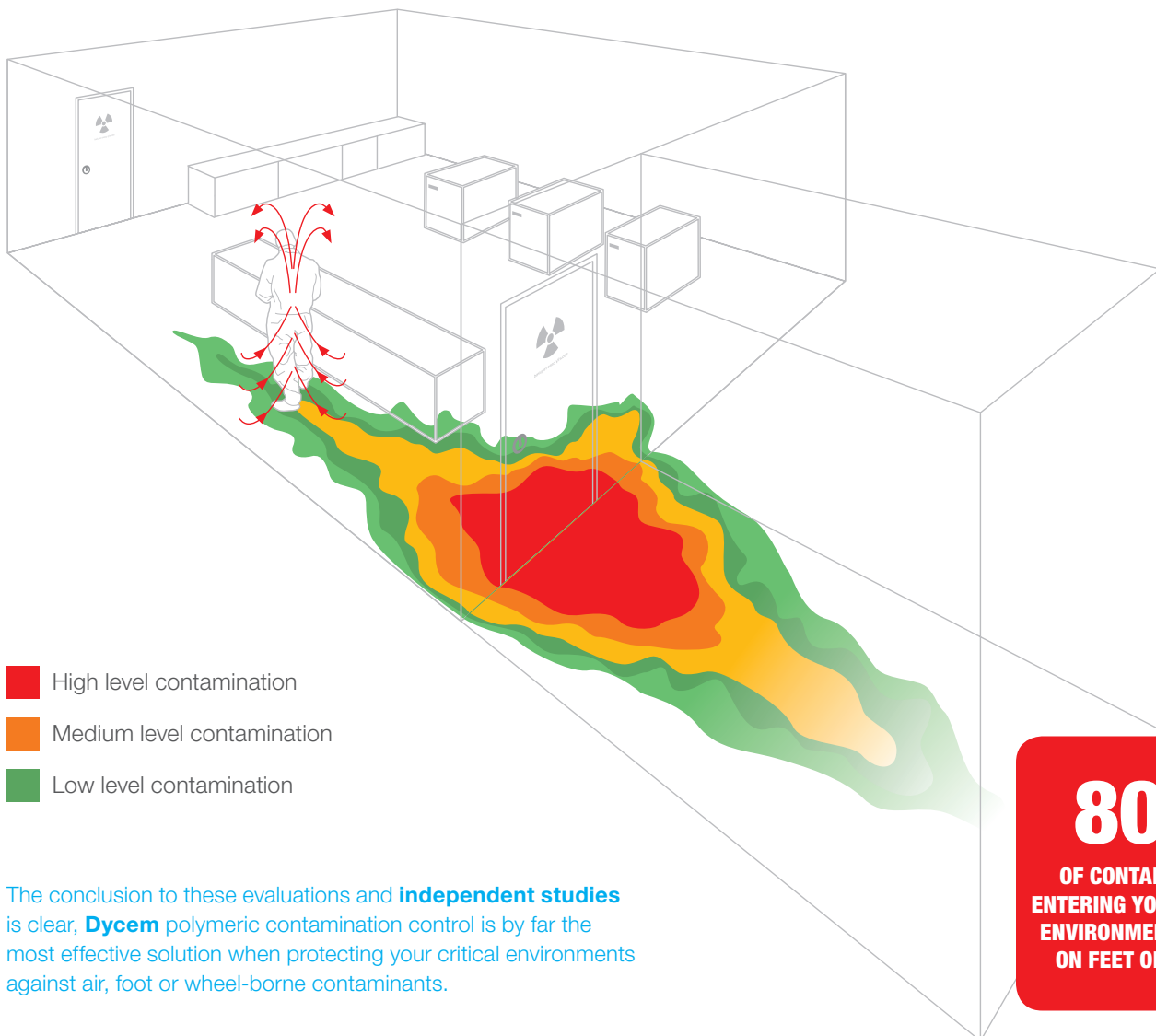

- High level contamination
- Medium level contamination
- Low level contamination

The conclusion to these evaluations and **independent studies** is clear, **Dycem** polymeric contamination control is by far the most effective solution when protecting your critical environments against air, foot or wheel-borne contaminants.

80%
OF CONTAMINATION
ENTERING YOUR CRITICAL
ENVIRONMENT DOES SO
ON FEET OR WHEELS



USING NOTHING

Particulate contaminants (both viable and non-viable) are known to adversely affect quality, product yield, operational effectiveness and profitability.

Using no contamination control at floor level poses a dangerous threat to clean areas. Particles below a size of 30 microns are not visible to the naked eye so viable and non viable particles are very likely to be present.

There are two main types of contamination:

1. **External** - gross atmospheric contamination, which infiltrates your facility.
2. **Internal** - the human body can generate 5-10 million skin, hair, dirt, and clothing particles every minute.

The risks for no contamination control include:

- Risk management policies being adversely affected as 100% of localised contamination and particles are allowed to freely settle.
- Feet and wheels will pick up and collect these particles transferring them into critical areas.
- Feet and wheels will also grind down these dust and dirt particles eventually to a size that will become subject to Brownian Motion (airborne particle movement).
- These airborne particles become suspended in the air and get carried into the critical area where they present a potential hazard.
- The cost of a contaminated product batch and potential shut down can cost up to millions of pounds per day.
- The above can be a risk to your profits.
- It can be a risk to your brand and reputation.

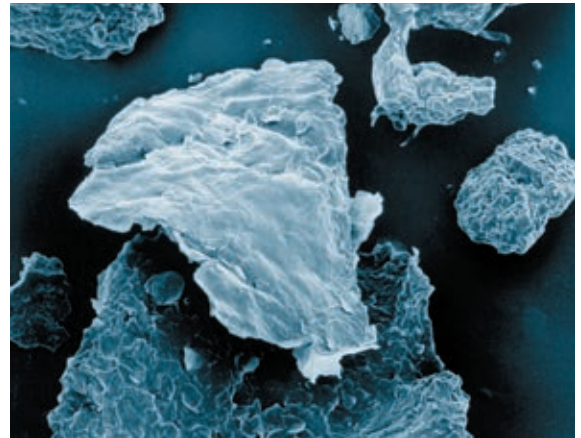

Scanning electron microscope image of human skin scales. [Mag x 500]

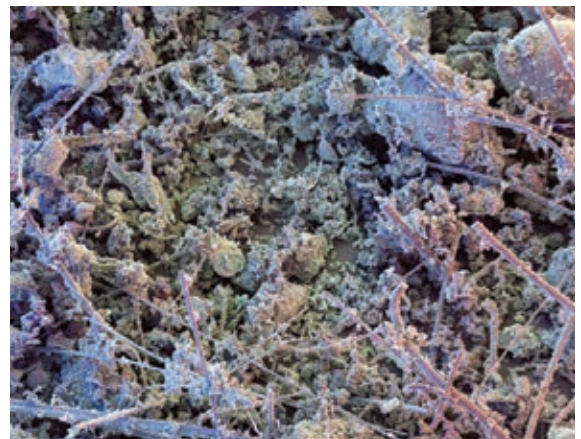

Scanning electron microscope image of human skin flakes. [Mag x 160]

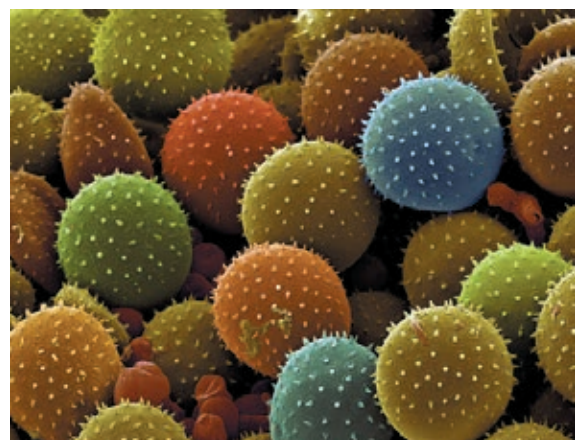

Scanning electron microscope image of fungal spores. [Mag x 500]

**ONLY
27%**
OF FOOT AND WHEEL-BORNE
CONTAMINATION IS
PREVENTED BY
PEEL-OFF MATS

PEEL-OFF MATS

It is commonly thought that using disposable, adhesive peel-off mats is the answer to contamination control. However, tests from GlaxoSmithKline show that peel-off mats are only 27% effective in preventing foot and wheel-borne contamination.

There are many manufacturers of peel-off mats which result in variable quality. The key concern is the thickness

and hardness of the acrylic adhesive applied during the coating process. If too thick and soft the adhesive transfers off the mat as people walk on it. Some peel-off mat companies even offer adhesive residue remover as they acknowledge the problem.

PEEL-OFF MATS THE RISKS

- Peel-off mats are not guaranteed to stay adhered to the sub-floor.
- There are risks of water ingress and microbial growth underneath.
- Corners peeling from the sub-floor can cause tripping/Health and Safety issues.
- Peel-off mats are prone to causing static charges generating up to 5,000 volts per peel.
- Peel-off mats can tear overshoes, exposing unclean surfaces.
- Adhesive from peel-off mats can be tracked into clean room environments on feet.
- Wheeled traffic can be difficult to move over the peel-off mats.
- Peels-off mats, in size, are much too small to effectively decontaminate.
- More often than not, multiple sheets are peeled, wasting money and time.



PEELING MATS CAUSE PARTICLE SHEDDING AND RECONTAMINATION

A study commissioned by a peel-off mat manufacturer highlighted the problem of particle shedding during the rip up process of peel-off mats. The tests revealed that on average, 215,000 particles were released during the rip-up process – releasing hundreds of thousands of particles back into the atmosphere.

**215,000
PARTICLES**
ARE RELEASED INTO THE
ATMOSPHERE DURING THE
RIP UP PROCESS



PEEL-OFF RISKS WITH WHEELED TRAFFIC

It is impossible to decontaminate medium to heavy wheeled traffic using a peel-off mat. This is due to:

- Peel-off mats being prone to wrapping around wheels of trolleys and carts making it impossible to control cross contamination.
- Peel-off mats are not efficient in dirtier and heavy traffic environments as they are prone to heavy saturation very quickly.
- Peel-off mats cannot allow the three full wheel rotations necessary to decontaminate wheeled traffic.
- Adhesive from peel-off mats can be transferred onto wheels and tracked into critical environments.



Peel-off mats wrap around the wheels of trolleys and carts

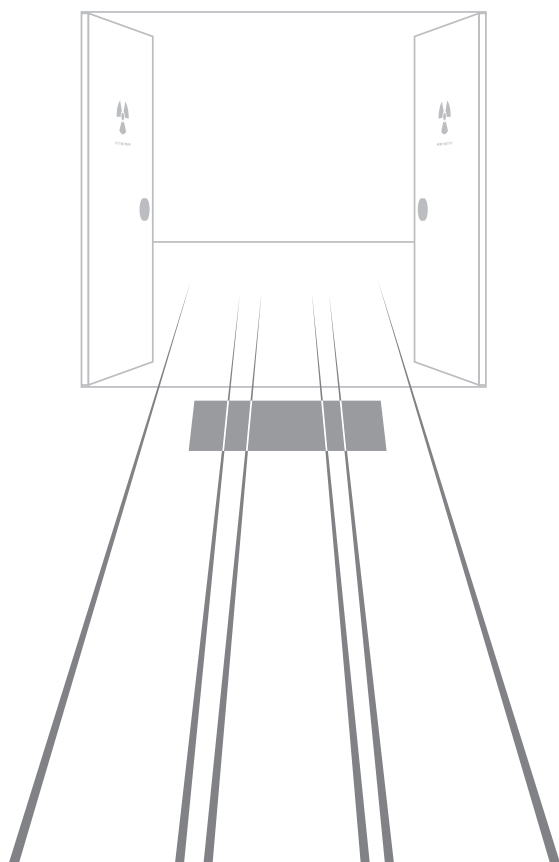

PEEL-OFF MATS

The small surface area of a peel-off mat makes **full** wheel-borne decontamination **almost impossible**.

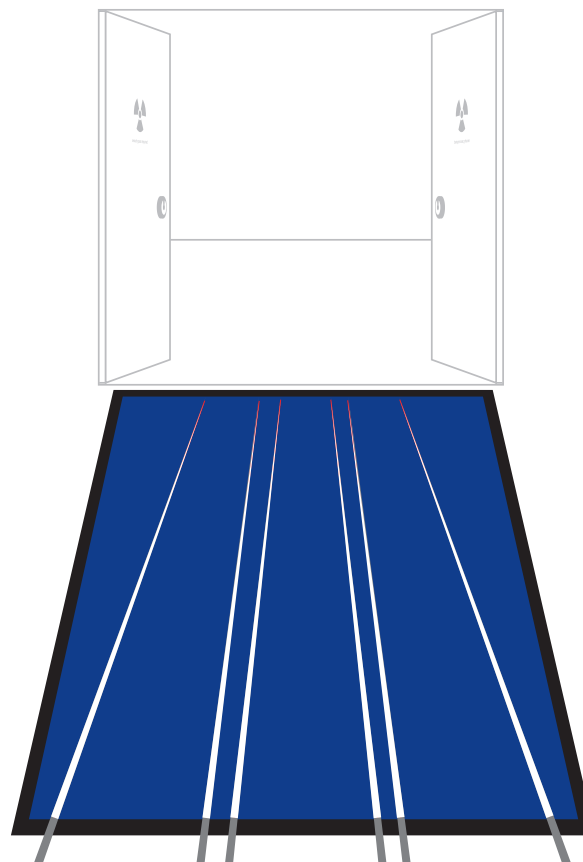

DYCEM

Dycem's larger surface area and polymeric construction allows for **full** wheel-borne decontamination of **99.9% possible**.

PAYING A HIGH PRICE FOR LOW COST ALTERNATIVES

The initial cost of peel-off mats may seem low and advantageous when meeting budgets, however peel-off mats actually cost significantly more than Dycem.

When comparing the two systems, Dycem not only costs less over the longevity of both products, but most critically, it vastly out performs in terms of size, quality and retention of contamination, reducing the risk of particles entering your critical environment.

Use the formulae below to see how much you spend on using peel-off mats, and how much you can save by switching to Dycem over a 3-year life cycle:

PEEL-OFF MAT COST

Peel-off mat cost x 10 (to create the size of Dycem) + peels per shift x shifts per day x days operation per year x 2 (Redisposal) Costs.

DYCEM COST

0 peels required x 2 shifts per day x 7 days per week (12 month replacement contract per pricing matrix).

Please contact us with your peel-off mat costs and we will be happy to show you how much you could save with Dycem.

ENVIRONMENTAL IMPACT

The **hazardous/contaminated waste**, coupled with disposal costs created with peel-off mats are not to be ignored. With the 20cm ball of waste created when peeling off a mat layer (generating enough waste to fill multiple dumpsters per year), and also being classed as secondary waste, Peel-off mats not only create an abundance of unnecessary waste but are very expensive to dispose of properly at the end its very short working life.

Dycem is easily integrated into your SOP and can be cleaned as part of your regular floor cleaning schedule. Dycem does not impact on your daily waste volumes and can either be disposed of normally in regular waste or recycled into less critical applications (after its minimum 3 year working life).

SINGULAR PEEL-OFF MAT

73%

CONTAMINATION ENTERING CRITICAL ENVIRONMENT

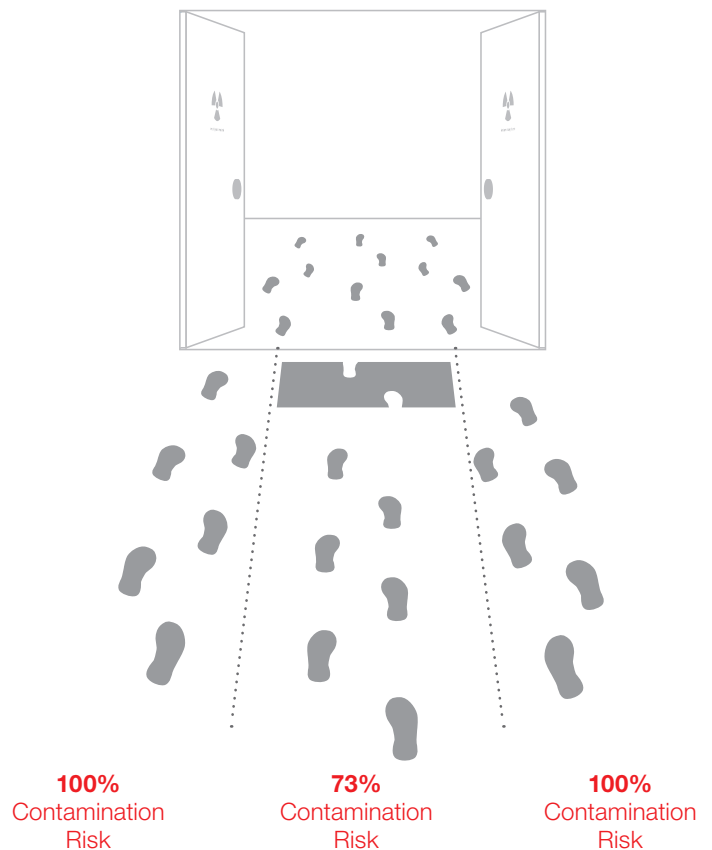

The average 1.2M x 0.6M (4' x 2') sized peel-off mats are too small. This coupled with the usual placement of only one mat outside critical areas can be very dangerous!

A singular peel-off mat will pose the most risk, with **73%** of contamination entering your critical area, this could be **100%**, as the likelihood of overstepping a singular mat is very high!



If your peel-off use and rate of peeling is very low there is **100% risk** to your critical environment due to high particle build up and peel-off mats inability to withstand overstriking.



**GANGED
PEEL-OFF MAT**

20%
CONTAMINATION
ENTERING CRITICAL
ENVIRONMENT

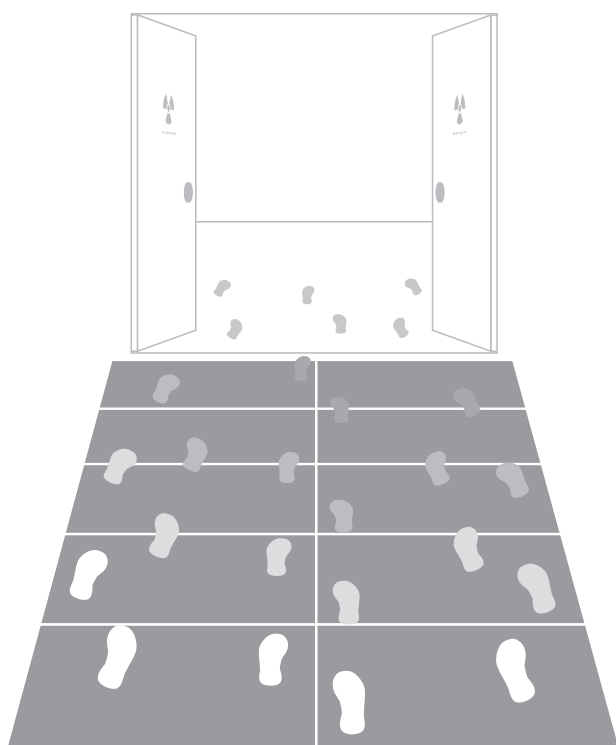

DYCEM

<0.01%
CONTAMINATION
ENTERING CRITICAL
ENVIRONMENT

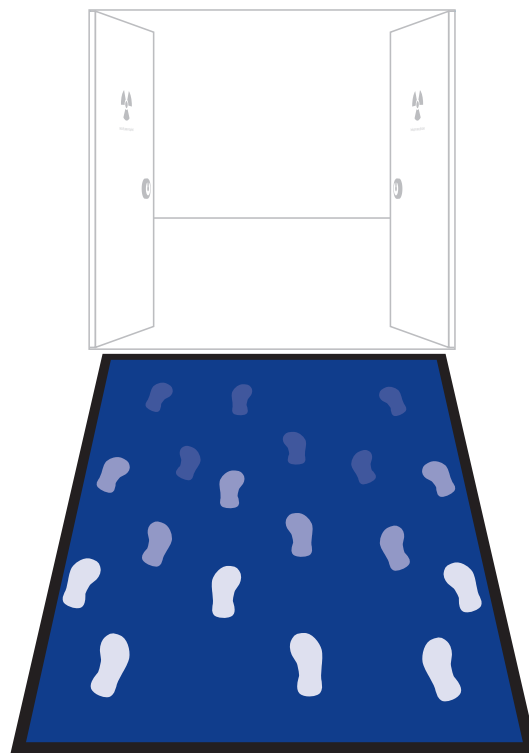

GANGING MATS TOGETHER

In order to get a near comparable performance to Dycem, at least eight peel-off mats need to be ganged together and peeled regularly.

Ganging peel-off mats together does address the size issue. However the practical issues, labour and material costs involved in peeling eight mats several times each shift make this an expensive option.

The return on investment (ROI) on comparable performance is about one year, but the far greater benefit comes from lower particle counts, leading to increased product yields.

10 Peel-off mats ganged together means there is 20% risk of contamination entering a critical area (if peeled twice per shift). Source: Mcon.

In addition, the corners of the peel-off mats can often rise causing contamination to reside between the mats. When peel-off mats are ganged together they harbour contaminants in the gaps between them. **Dycem is seamless**, thus avoiding this contaminant trap.

OVERSTRIKING

Extensive laboratory tests and practical experience have established that Dycem’s unique surface chemistry consistently removes more particulate than any other method of contamination control, both when Dycem is clean and partially contaminated.

The information below are results from ‘**Examination of air and surface particulate levels from cleanroom mats and polymeric flooring**’, **Dr Tim Sandle**. These results illustrate the performance of Dycem compared to other peel-off mats when overstriking.

TEST MATS	PARTICLE REPLACEMENT BACK ONTO SHOE FROM PEEL-OFF MAT
PEEL-OFF MAT 1	9.6% INCREASE
PEEL-OFF MAT 2	73.3% INCREASE
PEEL-OFF MAT 3	85.5% INCREASE
PEEL-OFF MAT 4	81.3% INCREASE
PEEL-OFF MAT 5	81.9% INCREASE
PEEL-OFF MAT 6	108.8% INCREASE
DYCEM POLYMERIC	90.3% PARTICLE REMOVAL FROM SHOE ONTO DYCEM

PEEL-OFF MATS’ UNRELIABILITY WHEN OVERSTRIKING

- The performance of peel-off mats is greatly reduced with overstrikes. If used correctly i.e. each person stops and takes at least three steps with each foot, overstriking will occur.
- To achieve the peel-off mat’s optimum 27% effectiveness they need to be peeled after every use.
- In addition, particles readily transfer back onto footwear, increasing the risk of contamination.
- Peel-off mats as a singular are too small. With every step, contamination builds up in layers on feet. This build up of contamination on feet will not be effectively removed after one or a couple of steps on the area.

When **overstriking** on Dycem a **further 90.3%** of particles are removed from overshoes, compared with an **increase of up to 381.9%** being deposited back onto the shoes using peel-off mats. **Source: Dr Tim Sandle**

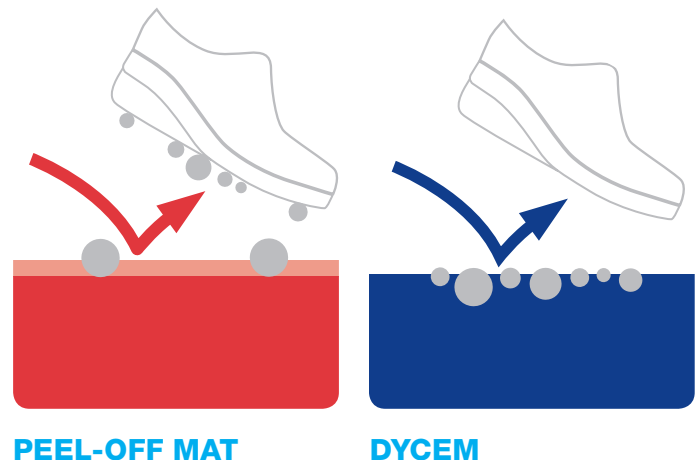

FOOT BATHS

Good personal hygiene polices and practices, as well as HACCP procedures are the foundation for successful food safety and quality assurance in all food manufacturing facilities. The goal is to have an effective barrier against microbial contamination from humans and/or equipment that travels through food contact areas.

Footwear can be a vehicle for the transfer of pathogens from production areas deemed as high risk to low risk areas. Therefore between these areas, many facilities decontaminate feet through the use of foot baths.

With this in mind, there are a few points to consider:

- In facilities or areas which utilise foot baths, it is essential that they are monitored to make sure that a 'bacteria bath' is not created.
- Foot baths need to be monitored not only for adequate concentration but also for appropriate volume of sanitising solution.

- Often, there is so much organic material built up in the container that there is no longer any sanitizer effectiveness.
- Ordinary foot baths do not provide any scrubbing action and therefore do not keep users from treading sediment back into the processing environment.
- The contaminated bleach in the foot baths need to be disposed of safely.
- Foot baths are not only costly solutions to install and maintain, but are disruptive to personnel workflow when using them.
- Foot baths can cause health and safety risks due to water spillage during usage i.e. slippages. Dry areas do not have this concern.
- Chemicals within the baths can be tough on shoe material through repeated cleaning regimes. This can be hazardous to critical environments if the shoes break down.



**Foot baths present a health & safety risk.
Water can cause personnel to slip.**

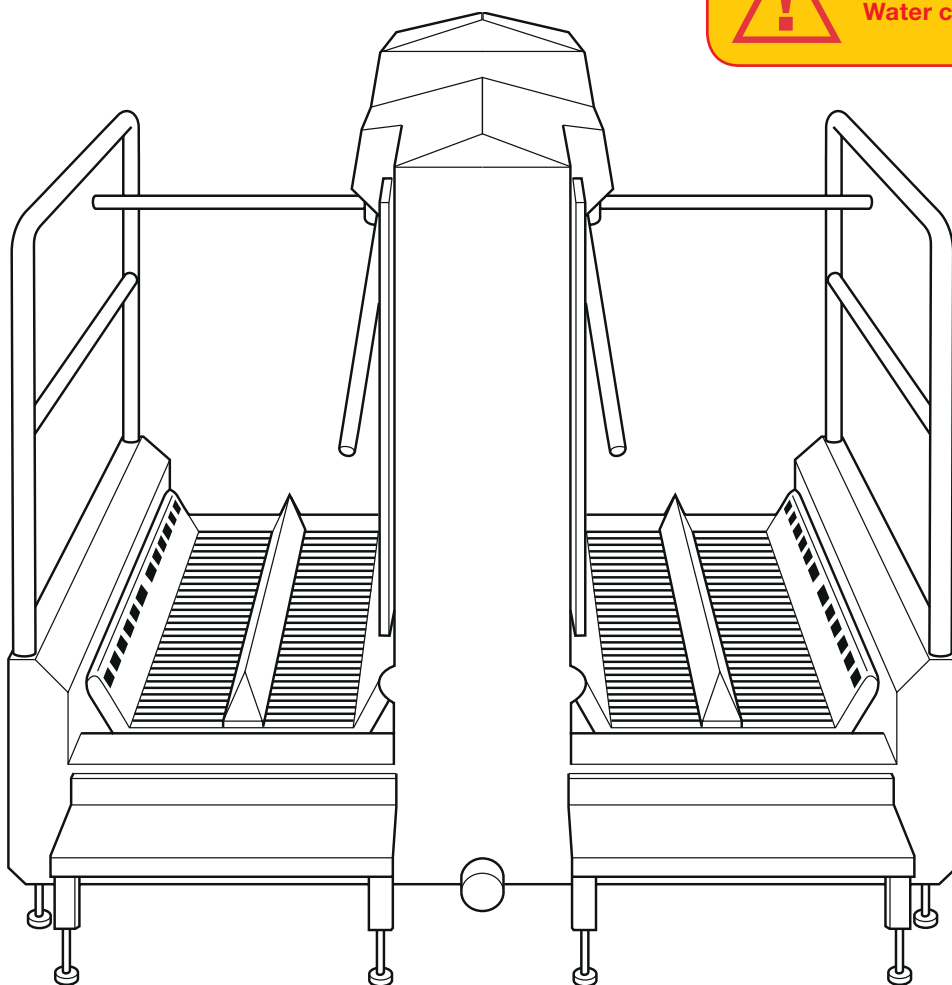



REDUCING THE NEED FOR **SHOE COVERS**

Shoe covers are commonly used in cleanrooms as a way to control foot-borne contamination. Though few who wear them give much thought to these critical environment consumables.

Many controlled environments might discover that they are using a shoe cover that is not only inappropriate for their environment, but is more expensive than a better suited product.

COST

The cost of shoe covers can vary greatly from high to low end products, both types with differing USP's and an organisation's aspiration for quality will greatly impact the cost on budgets.

QUALITY

Many manufacturers and/or distributors claim good traction, durability, waterproof capabilities and most of all contamination avoidance when selling shoe covers. However, the materials the shoes are produced from (Chlorinated polyethylene, polypropylene, PVC) all have inherent weaknesses that could cause risk to your critical environment.

RISK

Potential risks vary with shoe covers, depending on the materials produced. These risks include ripping, slipping of feet and inability to apply to larger feet. Polypropylene (PP) presents several problems in a controlled environment setting. PP is a non-woven material, which means that it can and will shed particles.

Furthermore, the highest risk is not necessarily through the usage of the shoes, but applying them to feet. Using dirty/unwashed hands bypasses the purpose of having shoe covers and adds contamination to the underside even before entering critical environments.

IS THERE A NEED?

Shoe covers are amongst a vast number of commonly used contamination control solutions, but when considering costs, usage and disposal, Dycem can prove to be an effective, high quality and lower cost alternative in the long run.

SHOE COVER COST FORMULA

Shoe cover x 2 (= 1 person) x individuals per shift x shifts per day x days operation per year. What also should be considered is time lost putting on and removing overshoes, and the amount of entry and exits per person per day in and out of the environment.

DYCEM COST

0 change over required x 2 shifts per day x 7 days per week (12 monthly replacement contract per pricing matrix)



PERFORMANCE COMPARISONS

Throughout this comparison brochure, we have discussed how different solutions vary in quality, price and performance when compared to Dycem.

Below is a simple and illustrative comparative breakdown between the main solutions implemented and how they compare.

Only Dycem, through scientific, independent studies can guarantee 99.9% foot and wheel-borne decontamination, and 75% airborne decontamination.



COMPARISONS	Dycem	Using Nothing	Peel-Off Mats	Foot Baths
Is 99.9% effective in inhibiting foot and wheel-borne contamination	✓	✗	✗	✗
Captures 75% of airborne contaminants	✓	✗	✗	✗
Doesn't redistribute particles back into the atmosphere	✓	✗	✗	✗
Doesn't harbour bugs	✓	✗	✗	✗
Can be recycled at the end of its lifecycle	✓	✗	✗	✗
Large surface area to allow for multiple footsteps	✓	✗	✗	✓
High surface energy	✓	✗	✓	✗
Adhesive free	✓	✓	✗	✓



LOW COST WITH HIGH RISK ALTERNATIVES

Other polymeric systems are emerging onto the market, but nothing rivals Dycem. We are the only company with independent scientific data that validates our product and its ability to protect your critical environments. Furthermore, our after sales service is unrivalled and as we manufacture in house, you are assured quality 100% of the time.

ONLY DYCEM OFFERS MULTIPLE SOLUTIONS

Dycem's vast range of products, solutions and service options, along with a wide variety of edging options, enables Dycem to create the best solution, bespoke to your needs. Other competitive products do not offer this complete solution.

DYCEM'S QUALITY AND ENVIRONMENTAL IMPACT

Dycem is ISO 9001:2008 and ISO 14001:2004 certified, assuring minimal environmental impact 100% of the time. Our products are also CE certified, conforming to requirements of the EC directives.

ONLY DYCEM HAS GUARANTEED RELIABILITY

Dycem effectively decontaminates foot and wheel traffic and comes with up to a 3-5 year performance guarantee when fitted by a Dycem approved flooring contractor.

PROTECTION OF CRITICAL ENVIRONMENT

Dycem will tailor all offerings to the bespoke needs of each and every individual customer, in whatever market, involving the development of a broad range of products designed to provide solutions in each and every situation.

ONLY DYCEM OFFERS TOP SERVICE THROUGHOUT

Dycem is more than just a product. Our team of contamination control experts ensure the best possible service in order to protect your critical environments.

This includes an in-depth site survey, consultation, top quality installation, after sales guarantee and support, and regular testing to ensure Dycem optimal performance.

Don't let us just tell you, view what our customers have to say in the testimonials section at the back of this brochure.

SYSTEMS COMPARISON	Dycem	Other Polymeric Systems	Peel-Off Mats
Ability to create bespoke sizes for any room construction types	✓	✓	✗
Reliable manufacturing quality everytime	✓	✗	✗
Fully edged and sealed system for seamless transition on and off the area	✓	✗	✗
Quality adhesive used ensuring full subfloor adhesion	✓	✗	✗
Specially selected backing materials for product reinforcement during life cycle	✓	✗	✗
Guaranteed decontamination performance for a minimum of 3 years	✓	✗	✗
Installed by approved service technicians	✓	✗	✗
Ability to clean and incorporate into SOP's	✓	✓	✗

ENTRANCE AND DUST MATS A COMPLEMENT TO DYCEM

Entrance and dust mats can be used to effectively capture large particles of contamination, ranging from typical mud, stones and water, to sand and salt grains (100 microns and above). Use an entrance mat for external environments and dust mats for internal environments in order to complement Dycem for gross contamination.

For areas subject to gross contamination, a dust mat can be placed within close proximity to Dycem and must be a minimum of 3 metres in length (allowing for six foot steps and three full wheel rotations required for decontamination).

Entrance and dust mats also have additional benefits:

- Slip resistance
- Water absorption
- Chemical resistance
- Reduces cleaning and maintenance bills
- Protects floors from wear and tear
- Can trap large dirt particles and water, preventing tracking onto Dycem, thus increasing Dycem's lifecycle

Tests conducted by 3M show “that a 1.5m run of entrance matting removes 30% of dirt and moisture, rising to 95% with a 9m run”

For our CZ02 product range (heavier traffic flows and wheeled traffic) we also recommend having a system in place to remove larger particles from wheels. We recommend the ProfilGate cleaning system to be placed in front of Dycem at goods in entrances to ensure maximum protection of Dycem during its lifecycle.

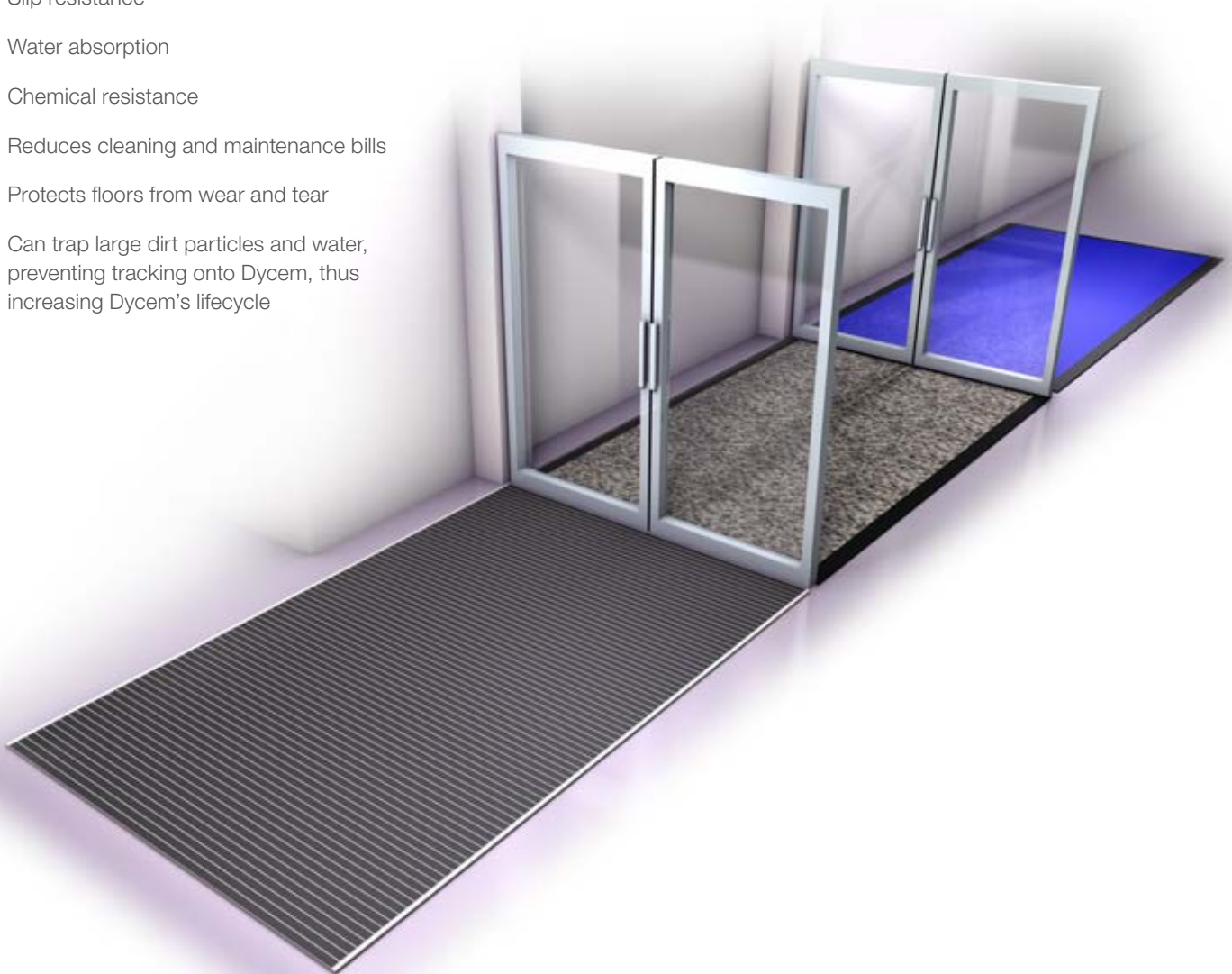

A PROGRESSIVE ZONAL APPROACH

Using a progressive zonal approach will enable effective decontamination of a vast range of particle sizes. Strategically placing a dust mat within areas close to external environments will capture particles of 100 microns and above, allowing for Dycem to effectively decontaminate particles below 100 micron, even down to 22 nanos, within more internal environments.

DYCEM POLYMERIC

22 nanos - 100 microns

Typical particles include mould spores and microbes

CRITICAL ENVIRONMENTS
INTERNAL ENVIRONMENTS

DUST MATS

100 microns and above

Typical particles include common dirt and sand/salt grains

INTERNAL ENVIRONMENTS
EXTERNAL ENVIRONMENTS

ENTRANCE MATS

Larger external environment particles

Typical particles include mud, stones, water

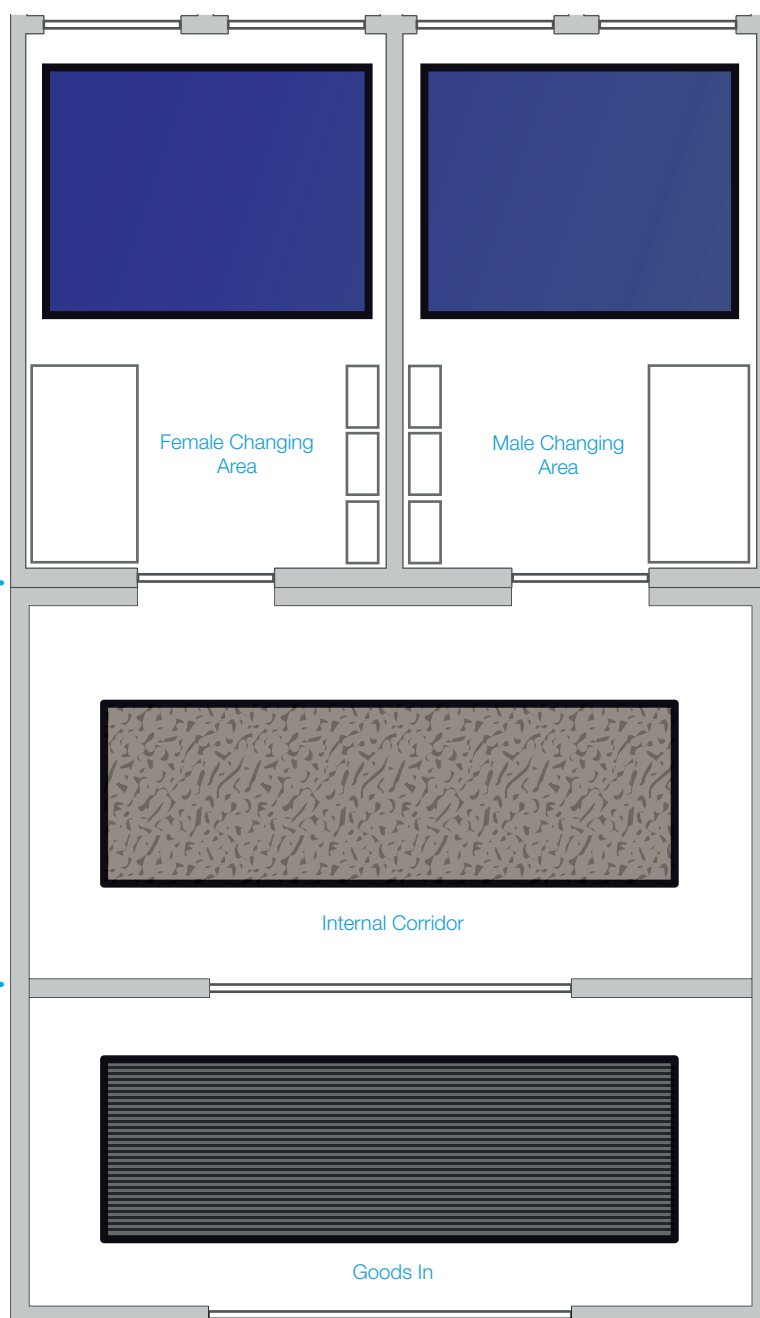

DYCEM CLEANZONE TECHNOLOGY

Dycem's High Performance Contamination Control CleanZones are easy to use and provide a simple, long lasting and highly effective method of minimising foot and wheel-borne contamination.

Dycem's polymeric composition ensures:

- 99.9% of foot and wheel-borne contamination is inhibited (Dr Caroline Clibbon, Senior Microbiologist, GlaxoSmithKline, UK). Dycem has also been proven to reduce airborne contaminants by 75%.
- Dycem's supple surface ensures that it wraps efficiently around shoe and wheel profiles, collecting the smallest of particles, with effective removal in the 2 to 10 micron range.
- Silver ion-based antimicrobial products are being used in Dycem's products and have been proven to be effective on more than 50 different organisms including MRSA and E.Coli.
- Optically smooth flexible surface enabling maximum contact between shoe and wheels.
- High surface energy (Van de Waals forces) allows maximum collection and retention of all particulate sizes.
- Simple and regular cleaning regime guarantees effective contamination control over several years.
- Particulates removed are contained within the controlled medium thereby preventing their release into the environment.
- Flooring can be recycled at the end of its life.
- Published independent tests (GSK, Sandle and Prout etc.) have proved that Dycem removes more particulate than any alternative method, both on a one step and multiple step basis.



SCIENTIFICALLY PROVEN TO CAPTURE AND INHIBIT 99.9% OF FOOT AND WHEEL-BORNE CONTAMINATION.





DECONTAMINATION ZONE

INSTALLATION DATE
REPLACEMENT DUE

EA DECONTAMINATIO
MAY LOOK DIRTY, THIS IS G
TION OF YOUR CRITIC



CLEANZONE TECHNOLOGY STOPS CONTAMINATION IN ITS TRACKS

Dycem's unique 5 way action is the only effective way to minimise foot, wheel and airborne contamination; Size, Silver, Suppleness, Smoothness and Service define the complete CleanZone technology package.

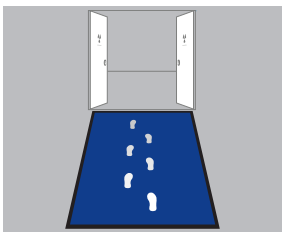

SIZE

It is well accepted that to effectively remove contamination from feet and wheels, it takes a total of six footfalls or three full wheel rotations. Only Dycem delivers this.



SILVER

Silver ion-based antimicrobial products from BioMaster are being used in Dycem's products and have been proven to be effective on more than 50 different organisms including MRSA.

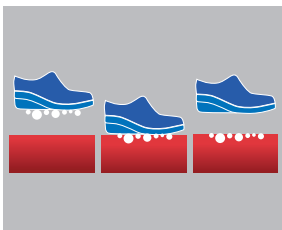

SUPPLENESS

Dycem's unique polymeric surface is soft and supple, conforming to shoe and wheel profiles and collecting particles between 0.1 and >100 microns.

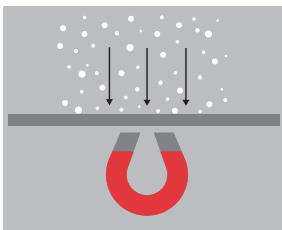

SMOOTHNESS

Dycem's exceptionally smooth surface creates a natural tack and a high degree of short-range electromagnetic forces (Van der Waals). This enables it to attract, collect and retain over 99% of particles.



SERVICE

Dycem offers complete customer support and helps you to define your contamination control needs with a free on site survey.

CLEANZONE TECHNOLOGY IN SUMMARY

This brochure has illustrated a number of possible methods and systems on the market for contamination control.

Dycem's polymeric flooring has been scientifically proven to be the most effective, long lasting and high performance method on the market for minimising foot and wheel-borne contamination.

- Dycem is scientifically proven to be the best.
- Independent testing illustrates the effectiveness of Dycem within your critical environments.
- Only Dycem offers these unique bundles of benefits listed in this brochure for your contamination control needs.
- Dycem's High Performance Contamination Control CleanZones are easy to use and provide a simple, long lasting and highly effective method of minimising foot and wheel-borne contamination.
- We have a comprehensive sales, service and distribution network covering more than 50 countries.
- We are confident in offering you genuine assistance on the products most suited to your facilities.
- Dycem is internationally recognised under the ISO 9001:2008 standard.
- Dycem is proud to have attained the ISO 14001:2015 standard demonstrating that an effective environmental management system has been successfully implemented.



INDEPENDENT STUDIES

SCIENTIFICALLY PROVEN TO BE THE BEST

Dycem has an extensive library of studies written independently. Here are just a few:

An evaluation of the effectiveness of polymeric flooring compared with “peel-off” mats to reduce wheel and foot-borne contamination within cleanroom areas.

Caroline Clibbon, Research Microbiologist at GlaxoSmithKline, Ware, Hertfordshire, UK

The nature and the environmental impact of control of floor level contamination.

Gerry Prout, Kennet Bioservices Ltd, Swindon, Wiltshire, UK

An evaluation of polymeric flooring and its effectiveness in controlling airborne particles and microbes.

Larry S Ranta, M-Con Technologies, Mission Viejo, CA 92691

A comparative Study of peel-off mats and polymeric flooring assessing their particle removal properties.

Dr. Tim Sandle, Microbiologist

A final floor show for bugs.

Dr. Tim Sandle, Microbiologist

A comparative study of two floor-cover materials in control of foot- and wheel-borne contamination.

Gerry Prout, Kennet Bioservices Ltd, Stratton St Margaret, Wiltshire, UK

Boehringer Ingelheim Manufacturing Site, Bracknell, Berks Installation of Dycem Polymeric Flooring.

S. Faizi - QC Microbiologist L.Southerby - QZ Microbiologist Team Leader

Particle Shedding from Tacky Mats.

John F. O'Hanlon Colleen E. McGowan Lisa M.Gustafson, Department of Electrical and Computer Engineering, University of Arizona

Clean Manufacturing: High Tack Polymeric Flooring.

Thomas Mulligan, May 2003

Stamping out particles.

Dr. Geoffrey Barrett

Polymeric flooring demonstrates particle retention properties.

Dr. Geoffrey Barrett

The evaluation of the Dycem screen for removal of microbial contamination from dust-laden surfaces.

Dr. N.A Hodges B.Pharm. Ph.D.M.P.S Department Of Pharmacy, Brighton Polytechnic, Brighton

Bacterial contamination control mats: a comparative study. *Microbiology Department, St David's Hospital, Cardiff*

A new concept in foot-borne contamination control. *Journal of the Society of Environmental Engineers, December 1976*

The use of polymeric flooring to reduce contamination in a clean room area.

Dr. Tim Sandle, Microbiologist

University of The West of England. Time lapse photography to demonstrate the potential antimicrobial abilities of Dycem contamination control flooring.

Dr. Gareth Robinson



Call Dycem now for a site survey or to request a copy of one of the studies mentioned above:

Dycem Ltd Europe

Ashley Trading Estate, Bristol BS2 9BB, United Kingdom
Tel: +44 (0)117 955 9921, Fax: +44 (0)117 954 1194
uk@dycem.com

Dycem Corporation

83 Gilbane Street, Warwick, RI 02886, USA
Tel: +1 1-800 458 0060, Fax: +1 401 739 9634
info@dycemusa.com

Dycem Corporation

1725 Hughes Landing Blvd, Suite 865, The Woodlands, Texas 77380

Dycem Asia

Unit 1205 Alpap II Building, Trade Street Corner Investment Drive, Madrigal Business Park Brgy, Ayala, Alabang, Muntinlupa City Philippines
Tel +632 807 6422 Info@dycemasia.com





TESTIMONIALS



“Independent tests carried out at GlaxoSmithKline prove that Dycem High Performance Contamination Control Zones prevent over 99% of all viable and non-viable foot and wheel-borne contamination from entering a critical area.”

Dr Caroline Clibbon, Senior Microbiologist, GlaxoSmithKline, UK



“We have recognized that the Dycem Zones work very well - confirmed by measurements made by the manufacturer’s representative - our powder remains in the zone and does not spread outside the production areas. I can only recommend the installation of Dycem zones—if you adhere to the rules for cleaning them, the effect is really noticeable.”

Sylva Balcárková, a Teva’s shift leader



“Dycem is the most cost effective means of controlling contamination at floor level and preventing contamination from getting into critical development work.”

David Williams, Honda



“Dycem High Performance Contamination Control Zones are great at trapping contamination and helping to clean-up various areas in the paint department, preventing contamination from affecting the paint finish.”

Gary Appleton, Ford



“We have used Dycem for many years in our aseptic processing areas. We use it in transfer hatches (for wheels) and at entrances and exits to restrict the outside micro-organisms from getting into the facility.”

David Cope, Kings College Hospital



“We have used Dycem for over 6 years, it is the most effective and cost effective method of preventing contamination down to less than 5 micron and stops it from getting into our photo mask manufacturing facility.”

Susan Jeynes, Project Engineer Photronics, Wales



“We have calculated that even a short time after installation we have saved money by using these products. I would like to add that the customer service has also been exceptional.”



“Since replacing Peel-off Mats we have seen a noticeable improvement in static charge within the labs and surrounding areas. We also found that a lot of dirt was building in between where mats were ganged together. A much more effective method of prevention.”



“We invested in Dycem some five years ago to protect our critical environments i.e cleanrooms and camera assembly. Owing to the success of our manufacturing we have now built new cleanrooms and improved the cleanliness of our controlled areas. The improvement in those areas is very much down to the Dycem product.”

Mark Wells, Sony, Wales



TESTIMONIALS



"It is of great importance to Seagate that contamination is kept to an absolute minimal possibility; we take great precautions to protect the production in all other areas. Dycem have provided excellent service alongside very high quality products."



"We have been so satisfied with the performance of the products that we are in the process of identifying additional locations where Cleanzone or WorkZone can be applied to further enhance our contamination control".

Nigel Dodd, Health Physicist at the PowerStation



"We found the service from Dycem particularly helpful when deciding which products would be of most use to ourselves in the company. We were greeted with a friendly and approachable team who were also available to answer any further queries we might have after installation".



"Dycem High Performance Contamination Control Zones have certainly reduced our particulate levels as well as cleaning costs. We have been very happy with the results and continued customer care that we have experienced from the Dycem team."

Monsieur Claude Muller, expert trainer in Techniques Aseptiques.



"We have found Dycem to very effectively live up to the statements it makes in its product policy. We require a very high standard of service which Dycem very effortlessly supplied us with. We will certainly consider using other products from the company in the future".



"We installed Dycem High Performance Contamination Control Zones 12 months ago as part of our ongoing programme to control contamination. It was so effective at removing contamination from both feet and wheels that we decided to increase the number of Dycem areas as we built our additional cleanrooms and moved

towards more controlled warehouse environments."

Suzanne Stubbs, Technical Manager, Shield Medicare.



"After researching many companies providing similar solutions, we were keen to use Dycem for their apparent cost efficiency. This has proved to be an absolute; we are convinced the installation has saved us a great amount in the long term".



"Dycem dramatically reduces the levels of dust from IT server rooms. IT cleaning have also found that although Dycem has to be cleaned on a daily basis its effect is to reduce the quarterly cleans to half yearly, enabling you to reduce your cleaning and maintenance costs".

Steve Yates, IT Cleaning.



REMEMBER ONLY DYCEM OFFERS:

- Contamination control flooring 2 metres (6'6" wide)
- Colour options to help mask captured contamination
- Independent scientific data and testimonials to prove product effectiveness
- Trained contamination control specialists that conduct detailed site surveys to ensure your facility is given the best solution

DON'T TAKE **THE RISK**

Call Dycem **now** for a site survey:

Dycem Ltd Europe

Ashley Trading Estate
Bristol BS2 9BB
United Kingdom

Tel: +44 (0)117 955 9921
uk@dycem.com

Dycem Corporation

83 Gilbane Street
Warwick, RI 02886 USA

Tel: +1 401 738 4420
info@dycemusa.com

Dycem Corporation

1725 Hughes Landing Blvd,
Suite 865, The Woodlands,
Texas 77380
USA

t: +(1) 832-447-1420
contact@dycem.com

Dycem Asia

Unit 1205 Alpap II Building
Trade Street Corner
Investment Drive Madrigal
Business Park Brgy, Ayala,
Alabang, Muntinlupa City
Philippines

Tel +632 807 6422
Info@dycemasia.com



www.dycem-cc.com



Cert No. FM23716
ISO 9001:2008



© 2017 Dycem Ltd Europe. All rights reserved.